



# MAGNA-LOC 180

# ROOF SEAMER

# FIELD GUIDE

*Part# 50985*

9.14.23



Contact us at 1-888-343-0456 or online at [www.diroofseamers.com](http://www.diroofseamers.com)

D.I. Roof Seamers  
915 Highway 45  
Corinth, MS 38834

***\*READ COMPLETELY BEFORE OPERATION OF MACHINE OR TOOLS\****

Safety Regulations set forth by the Occupational Safety and Health Act, local, state, and/or federal agencies should always be adhered to.

# IMPORTANT INFORMATION

---

- This Roof Seamer has been set up for your specific panel profile. Never use this machine on any other panel or profile.
- Do not attempt to alter or modify the machine in any way.
- Follow all safety suggestions and warnings in this guide as well as those posted on the machine itself.
- It is recommended to “seam as you go”. In other words, seam the panels as they are being installed. This helps ensure that each panel is kept within module and installed correctly. If you cannot “seam as you go”, the order of seaming should follow the order of panel installation. The first panel installed should be the first panel seamed.
- Use only D.I. Roof Seamers hand crimpers.
- Use heightened attention when seaming the first few seams, until a pattern of properly seamed ribs is established. Then, follow the same process on similar seams. Again, use heightened attention if conditions change, such as different support types, clip spacing, or roof slope.
- Per panel manufacturer’s specifications, each clip must be manually crimped to a 90° seam during panel installation. Clamps used on each side of the clip will ensure a quality crimp.
- For additional information, visit [www.msseamers.com](http://www.msseamers.com)

## **IMPORTANT**

### ***Required extension cord size:***

Distance (FT)	0-100	100-200	200-300
Wire Gauge (AWG)	10	8	6

## SCAN OUR QR CODES FOR FURTHER INFORMATION



### **Operational Videos**



### **D.I. Roof Seamers App**

This is a single direction 180° Roof Seamer. It will complete the 180° (Double Lock) seam in a single pass. You simply engage it on the hand-crimped portion of the seam and apply power. It is important to remember to use extreme caution when reaching the edge of the roof. Stop and disengage the locking handles of the seamer while the wheels remain on the roof panel.

“Single Direction Seamer” means that the seamer must run from eave-to-ridge or ridge-to-eave, depending on the direction of panel installation. When this type of seamer reaches the end of the panel, it must be removed and transported back to the starting end to seam the next rib.

Do not run the seamer within 6” of the end of a panel without using extreme caution. Hand crimping this area may be necessary if there are safety concerns or risks. Use your hand crimpers to finish any area that the seamer may not be able to complete such as the ridge cap area, end lap, or pitch change in the roof. Hand crimpers can be rented from D.I. Roof Seamers.

Your 4-Station Roof Seamer motor requires a 20-amp, 120-volt AC power supply. Poor performance and motor damage can result from the use of an improper power supply.

**Note:** Images used in this guide are for representation purposes only and may not be exact to your job.

## STEP 1

---

Before beginning, ensure that the panels are installed correctly and are free of all debris and contaminants such as sand, snow, excessive fluids, sealant/mastic, tools, extensions cords, etc. Keep a safety tether attached to the seamer anytime it is on the roof to prevent it from falling off. Failure to do so could result in machine damage, serious injury, and/or death.

**Note: The machines tether point is not intended to arrest the machine during a free fall from the roof.**

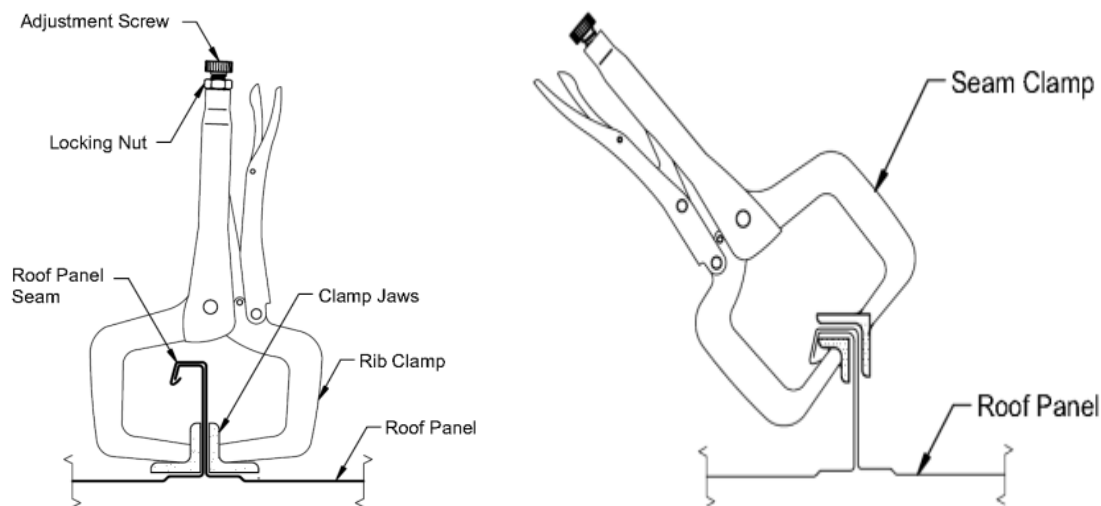

## STEP 2

---

Crimping at the beginning of each panel is required to start the seamer. Some panel manufacturers require that each panel clip be crimped to a 90° seam before seaming. Please contact D.I. Roof Sealers to rent the correct crimpers for your panel profile.

### CRIMPING PROCEDURE AT CLIP LOCATIONS

---

**Step #1-** Ensure that each panel overlap is properly engaged over the clip before crimping.

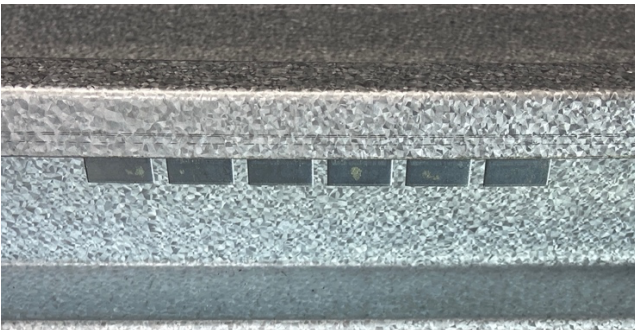

Exposed Clip from Improper Panel Engagement

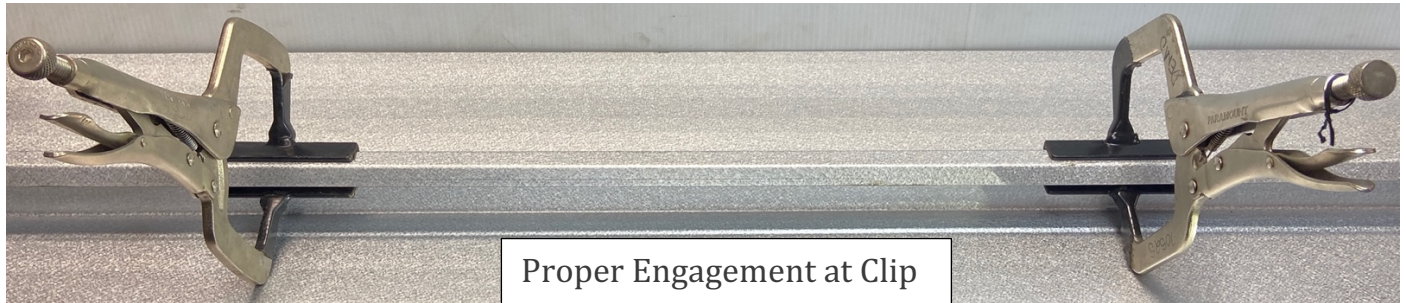

Proper Engagement at Clip

**Step #2-** Crimp each clip location with either our single phase 90° crimper or the Stage #1 side of our 2-Stage crimper.

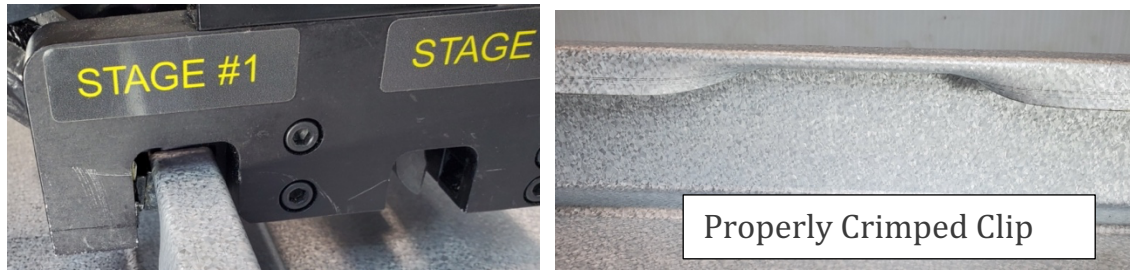

Failure to follow these crimping procedures will potentially result in machine and/or panel damage.

**DO NOT OVER-CRIMP. THIS WILL DAMAGE THE CRIMPER.**

**NEVER DOUBLR LOCK (180°) AHEAD OF THE SEAMER.**

## **CRIMPING PROCEDURE**

---

**Step #1-** Starting at the end of the panel, crimp 16” with your 90° (Stage 1) crimper.

**Step #2-** Go back to the end of the panel and crimp 4” with your 180° (Stage 2) crimper.

When finished, your crimp should be identical to the one shown below.

Failure to follow these crimping procedures will potentially result in damage to the machine and/or the panel.

**DO NOT OVER-CRIMP. THIS WILL DAMAGE THE CRIMPER.**

**NEVER DOUBLE LOCK (180°) AHEAD OF THE SEAMER.**

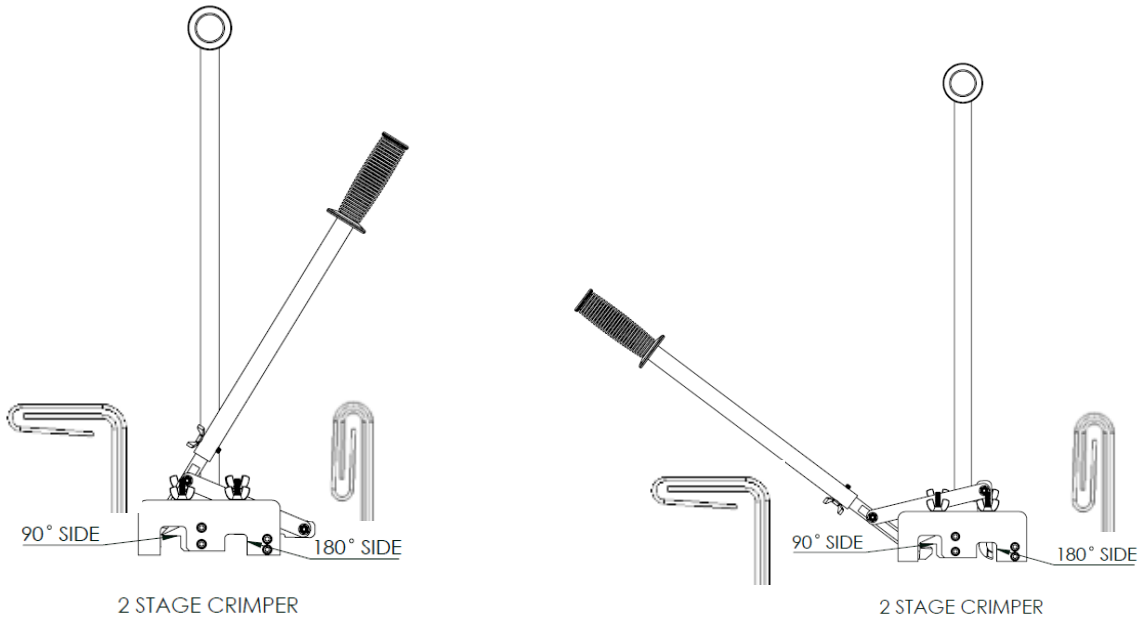
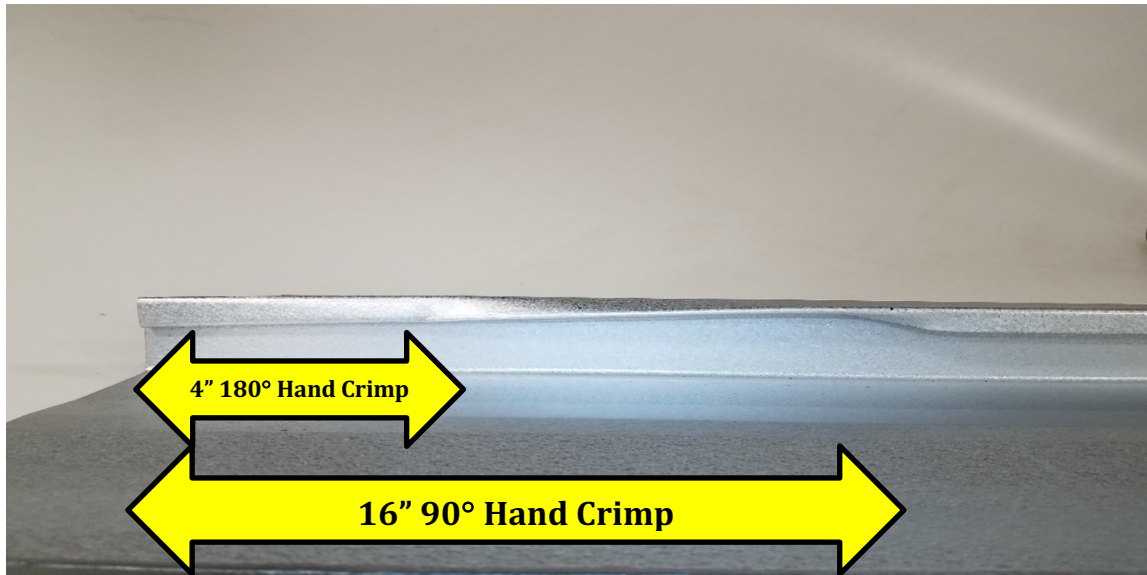

## STEP 3

---

Place the machine on the hand-crimped portion of the panel at the beginning of the seam, then engage by pulling the handles into the locked position. See the proper seamer engagement in following picture.

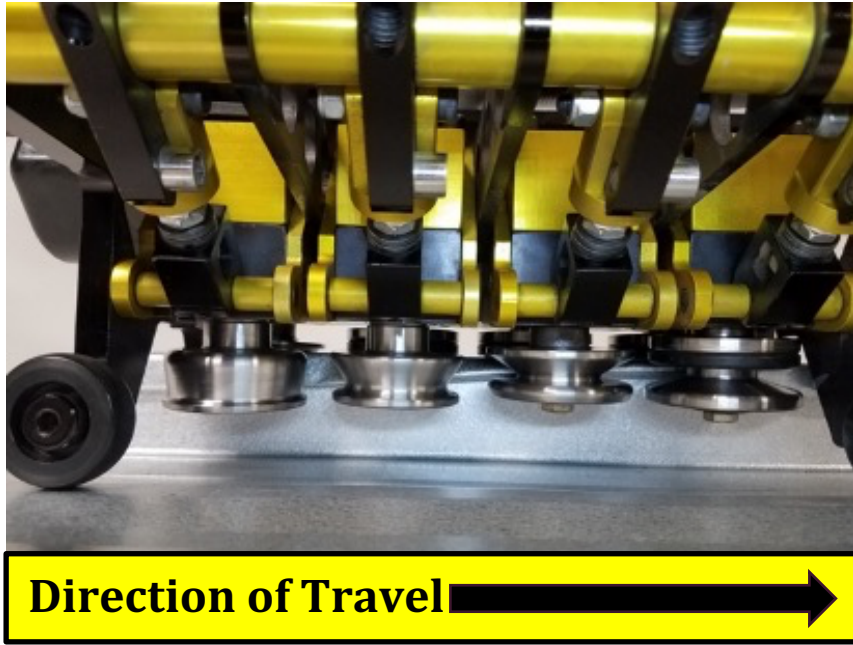

**The seamer must be engaged in this manner. Failure to do so will result in panel damage.**

## **ROLLER PROGRESSION**

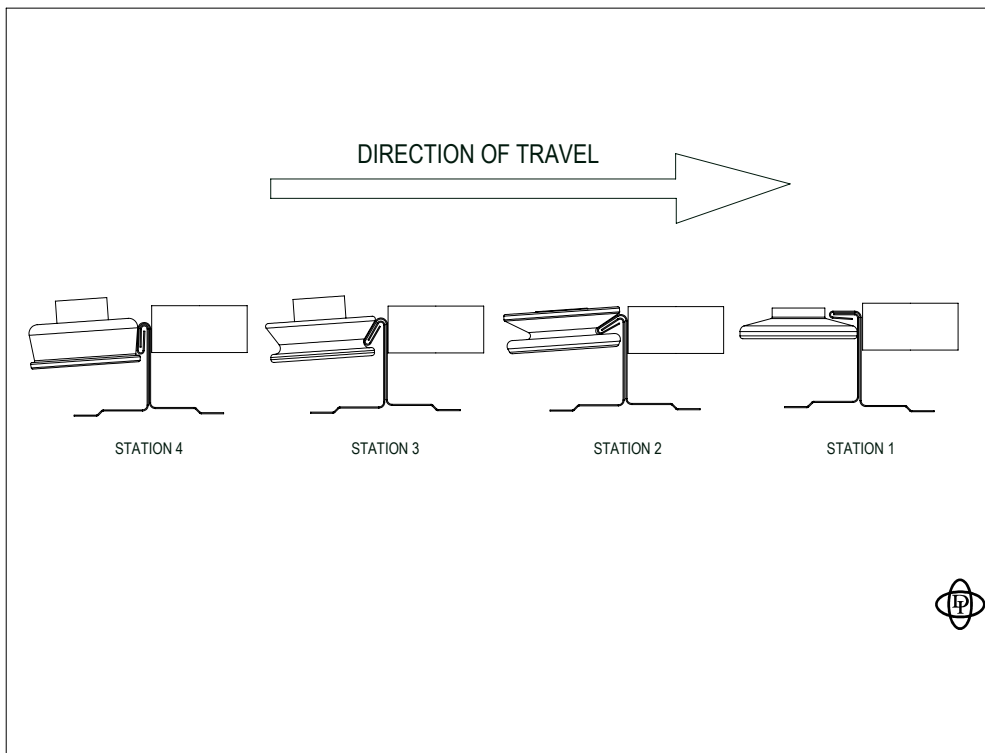



## STEP 4

---

Connect the power supply into the quick-release plug near the handle of the machine and turn the machine on. Run the seamer approximately 12” to ensure that you are receiving the desired seaming operation. If there are any issues, stop immediately and **contact D.I. Technical Support at 1-888-343-0456.**

## STEP 5

---

Stop the machine near the end of the panel and remove it from the rib by pushing handles 1 thru 4 into the disengaged position. Lift the seamer off the rib and transport it back to the starting end of the next rib to be seamed.

**Note:** This is a single direction seamer. If your panels are installed left to right the machine will run from the ridge to the eave. Alternatively, if your panels are installed right to left the machine will run from the eave to the ridge.

**Note:** The roof seamer may leave dark forming marks on light-colored panels. This is acceptable as long as the paint finish is not damaged. Marks can be rubbed off by hand – DO NOT use solvents that will soften or remove paint.

# MAINTENANCE REQUIREMENTS

---

- This machine requires daily cleaning. Additional cleaning may be required based on job site conditions. It is imperative that tooling is kept clean and free of debris.
- When not in use, always store your roof seamer in a dry place to prevent damage to the machine. **NEVER** operate it in inclement weather, such as rain, thunder, lightning, or snow.
- Each day that the seamer is to be used, ensure tooling bolts are tight to 25 ft-lbs. before the beginning of any seaming.
- If you need D.I. Technical Support, please **contact us at 1-888-343-0456.**

